



Door Systems
for Health Care
50th Anniversary Edition



Innovative • Elegant • Horton



With the broadest selection of healthcare products in the industry, Horton makes a difference in the patient experience and hospital efficiency.

Hospitals and medical facilities have specialized access needs that drive the toughest building codes. Horton continues to address these needs by developing first-to-market systems such as the self-closing smoke-rated ICU/CCU door systems and the first airborne infection isolation room door that requires no power. Staff as well as patients appreciate design details such as Mini-Blind and Opaque glass for privacy, light control and hygiene. Larger openings for moving beds and equipment are also now possible with the smoke-rated telescoping door system.

All around the facility, Horton systems are creating Grand® revolving door entrances, hard working interior and exterior doorways in swing, slide or folding solutions, and even drive-up convenience with pharmacy windows. Unlimited custom configurations can be planned for any of these areas to differentiate your design.

Product Functions



Self Closing



Breakout



Automatic



Manual



ADA



Smoke Rated



Security



Energy Efficient



What Sets Horton Apart

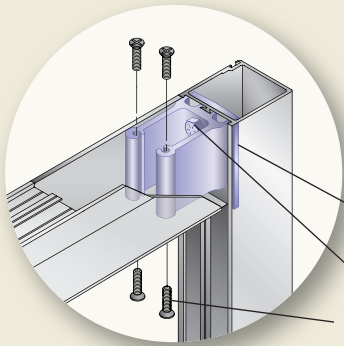

Rugged Corner Block Construction

Heavy duty rails with integral corner blocks add structural integrity to all Horton door systems. This exclusive mortise-style corner block construction is far superior to mass produced through-bolt doors.

Concave steel back-up plate engineered as built-in self locking device for Grade 8 bolts

Two Grade 8, 1/4-20 bolts secure corner block to vertical rail

Four #10-24 bolts secure corner block to horizontal rail

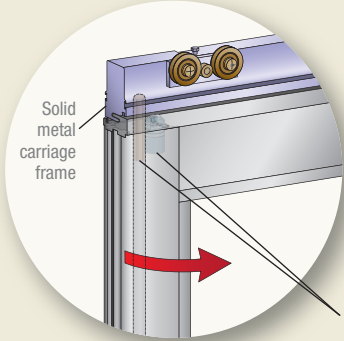

Solid Metal Carriage Frames Reduce Maintenance

Emergency breakout panels are constructed with a heavy duty, solid metal top frame. Better than competitive thin-wall hollow extrusions, this exclusive Horton feature protects the guide wheels and withstands breakout forces that compromise system longevity.

Heavy duty ball catch and system lock bolt within panel

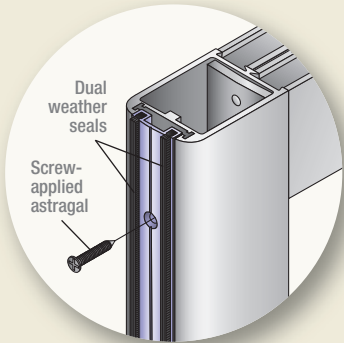

Double Astragal Weather Seals Save Energy

Weather seal material is captured in aluminum extruded astragal that is screw-applied to panel rather than with adhesive as mass produced systems. This creates a positive seal that stands up to wind as well as to the highest traffic conditions.

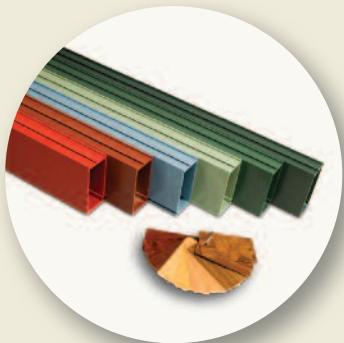

Custom Finishes To Enhance The Aesthetics Of Your Design

Horton door systems may be specified with powder coat finishes in a wide range of custom colors including wood grain. Thermally cured for toughness, these earth-friendly PVDF coatings* offer superior durability and color retention, even in the harshest environments.

*VOC-free, consistent with your LEED objectives

Brass Alloy & Stainless Steel

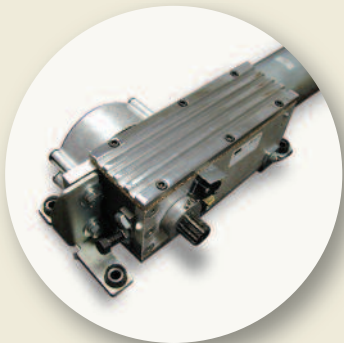

Robust

Horton's electromechanical designs deliver years of trouble-free performance with units tested more than 5 million cycles.



Standard and Custom Solutions

Overview 2-5

Intensive/Intermediate/Critical

Care Unit Systems 6

Profilor® 6

Profilor® Self-Closing ICU 7

Profilor® Smoke Rated Telescoping ICU 7

ICU/CCU Bi-Fold/Bi-Swing™ 7

Patient Room Systems 8

Profilor® Sliding Patient Door Systems 8

Profilor®-ICU SmokeSwing™ 8

Negative, Positive, & Combination

Pressure Room Systems 9

Airborne Infection Isolation Systems

2000-IDS 9

Self-Closing IDS 9

UltraClean™ 9

Automatic Entrance Systems —

Sliding 10

Elegant™ 10

Profilor® 11

ProSlide™ 11

ProSlide™ Telescoping 11

Automatic Entrance Systems —

Swinging & Folding 12

HD-Swing™ 12

EasyAccess® 13

HD-Swing™ LE 13

Custom Swing Door Packages 13

Specialty Operators 13

FoldingAccess™ 13

Automatic Entrance Systems —

Revolving & Security 14

Grand® 14

MiniGrand® 15

ControlFlow™ 15

Security Windows 15



Intensive/Intermediate/Critical Door Systems

Patients are always in full view through the sliding glass door. The full breakaway feature allows for all panels to swing out of the way providing a large opening for swift removal of patients or equipment.



Revo

Turn an ordinary entrance vestibule system. This large entrance easily accommodates

Complement your sophisticated design and creativity with Horton's unparalleled product offering.

- Main Entrances
- Emergency
- Administration
- Intensive Care
- Newborn Intensive Care
- Pediatric Care
- Bariatric Care
- Intermediate Care
- Cardiac Care
- Patient Care
- Surgical Rooms
- Radiology
- Nursery Units
- Corridors
- Pharmacy
- Gift Shop

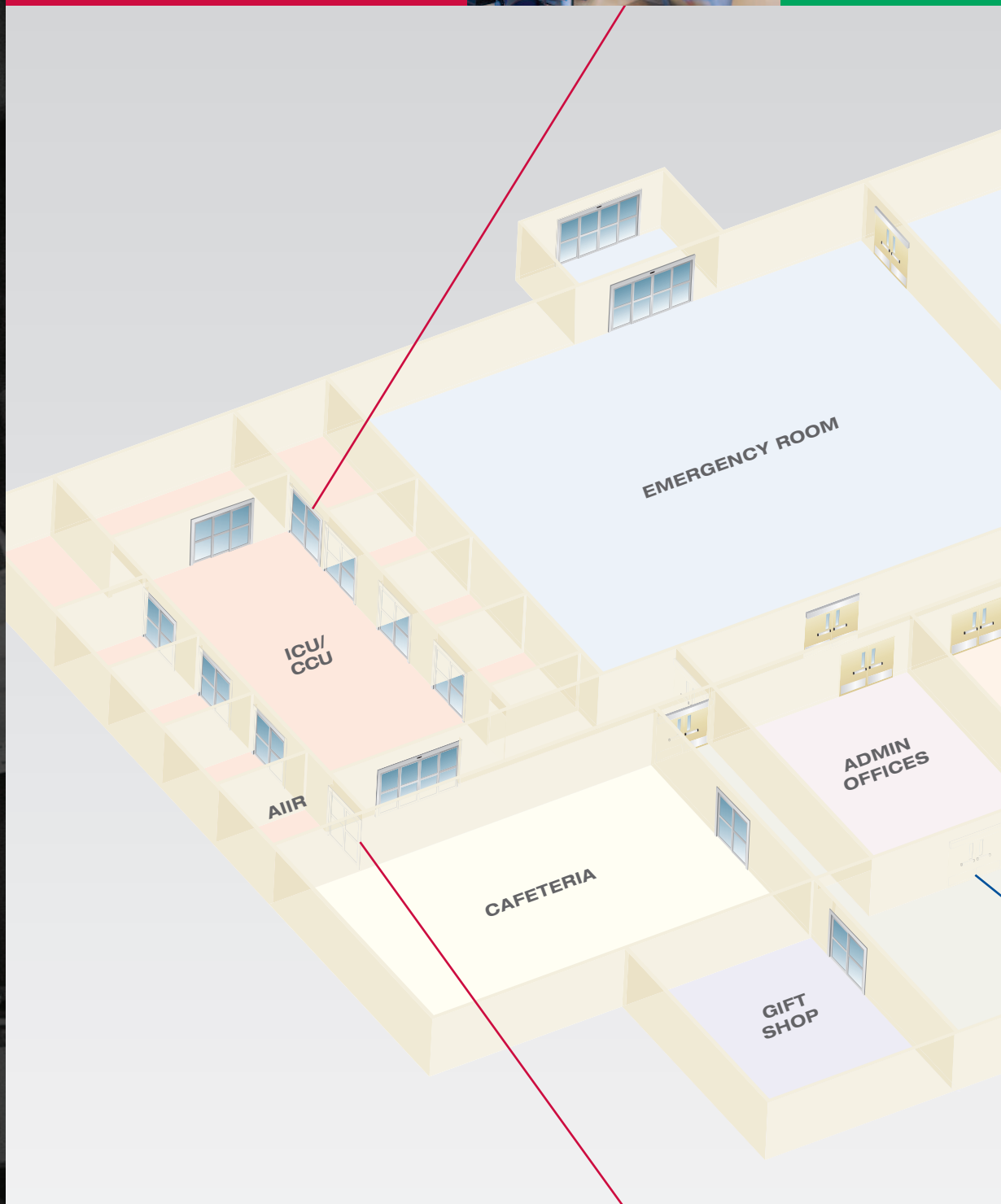

Negative, Positive and Combination Pressure Room Systems

Available in automatic and mechanical self-closing, these systems provide the option for an architect to address multiple areas where Airborne Infection Isolation Room (AIIR) doors may be needed.



Sw

Designed for high convenience and reliability applications will satisfy a

Sliding Door Systems

Entrance into an energy-efficient
large diameter automatic revolving
doors for wheelchairs and gurneys.



Patient Room Systems

With the greatest width and clear opening
available, these door systems are built with
beauty and functionality in mind.

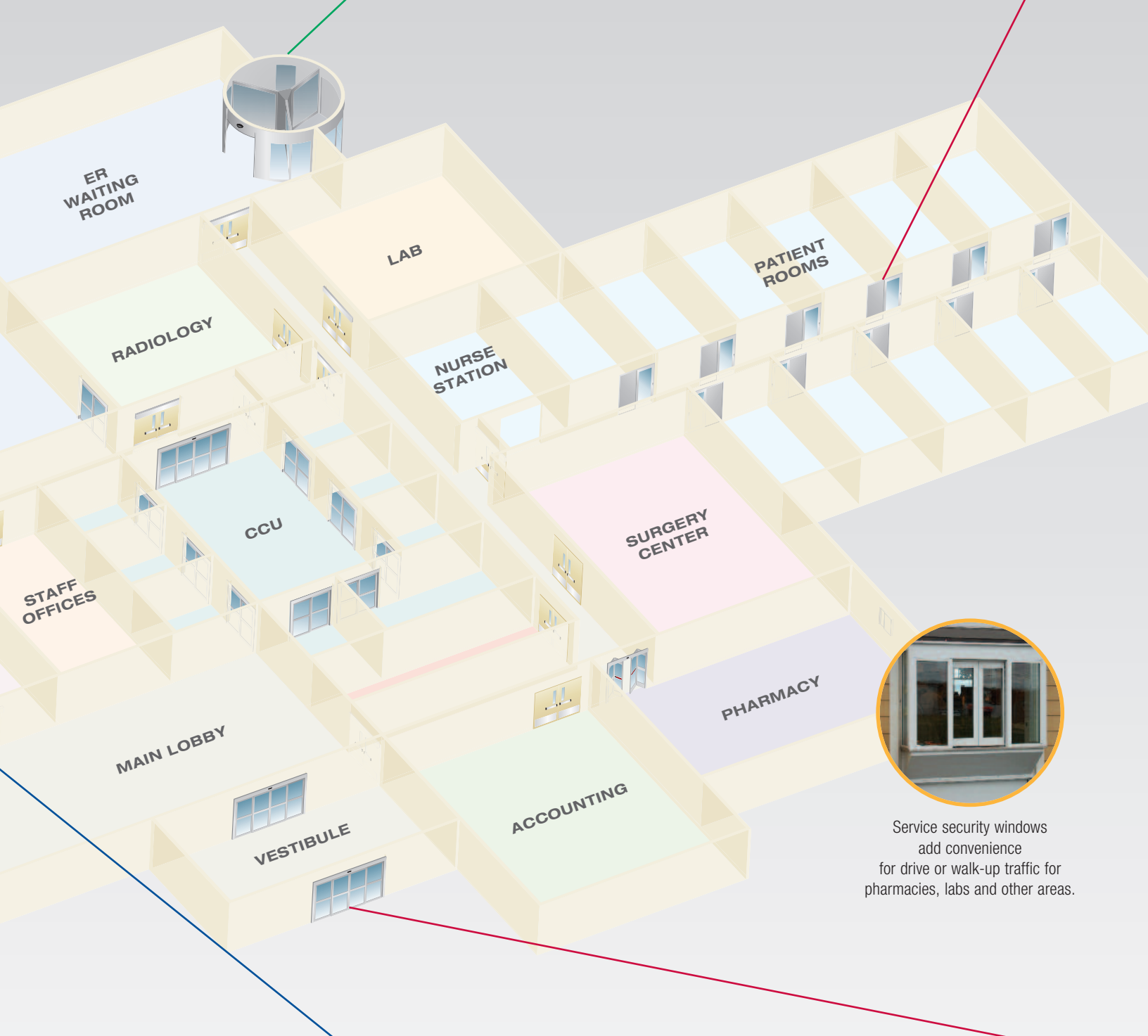

Service security windows
add convenience
for drive or walk-up traffic for
pharmacies, labs and other areas.

Sliding Door Systems

High traffic entrances providing
accessibility. The variety of designs and
finishes meet any architectural requirement.



Sliding Door Systems

Our broad offering of sliding doors gives you a wide
range of choices to meet your exacting requirements
for size, color, finish and security.



Intensive/Intermediate/Critical Care (ICU/IM)



Profiler®-ICU Standard Package Systems

Available in standard and custom non-smoke rated configurations, this multi-function system allows the architect greater flexibility in room design. Systems come with a choice of multiple header and threshold configurations.

Additional Features

- Single, biparting, telescoping, and slide/swing systems available
- Standard with recessed pull handles or optional positive latching handles available
- Clear opening widths available up to 85"
- Standard packages available with smoke-rated options

Specification Key (System Types)

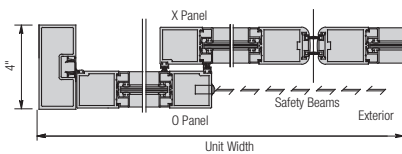

Type 010
No breakout capability.
Doors slide to interior of fixed sidelites.

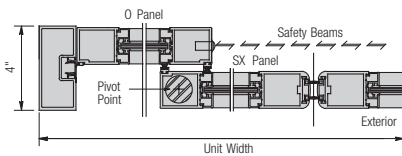

Type 110
Moving panels break out.
Doors slide to the exterior of fixed sidelites.

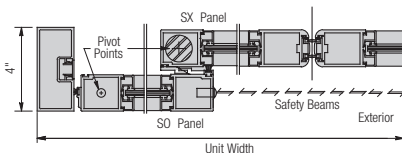

Type 310 (most common specification)
All panels breakout.
Largest break out area for moving wide objects.
Doors slide to the interior of fixed sidelites.

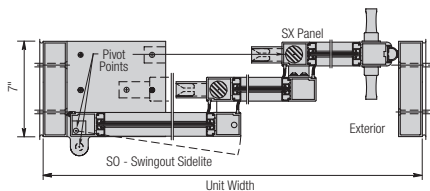

Type 310T (Telescoping)

Consult factory for other options

Horton Automatics ICU/IMU/CCU sliding system widths range from 7 to 12 feet with door configurations offered in 2, 3, or 4 panel designs for single, biparting, folding or telescoping applications. Narrow, medium and wide stiles are available with the choice of anodized aluminum, paint or clad finishes.

Standard Features

- ▶ Exclusive high-strength corner block construction
- ▶ Rugged breakaway system featuring full-width solid torsion bar assembly to provide superior support in the breakaway position. The only UL listed system in the industry.



Positive latching handles with modified door nosings, bottom rails and interlock seals

Applications

- ▶ ICU/IMU/CCU
- ▶ Patient Rooms
- ▶ Administration



Multi-access design allows moving patients and equipment easily



Thin rails allow for greater patient visibility

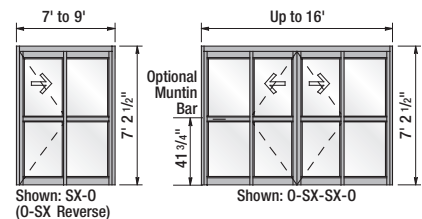

Type 110 - Single

Type 110 - Biparting

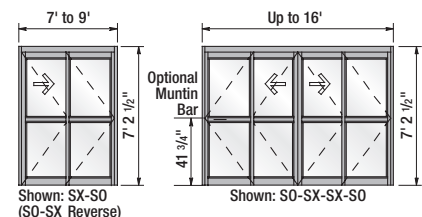

Type 310 - Single

Type 310 - Biparting



To view our new healthcare product video, use your smartphone to access the QR code.





Profiler® Self-Closing ICU Smoke-Rated Trackless System

This innovative system has an adjustable spring closing mechanism in its slim profile header. It can be applied anywhere without the use of electrical power.

Additional Features

- Available for openings ranging from 7' to 9'
- Available with a magnet to latch or positive latch
- Clear opening widths up to 44 7/8" with positive latch and 48" with magnet-to-latch
- Available with electromagnet that closes door when the fire alarm is triggered (power required)



Self-closing with adjustable hydraulic damper for smooth closing



Manual opening with hold-open feature

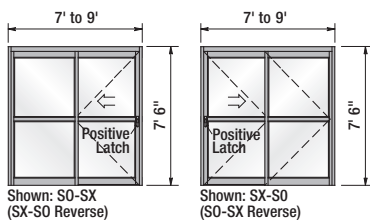

Shown: S0-SX (SX-S0 Reverse)

Shown: SX-S0 (S0-SX Reverse)

Type 110
Single

Type 310
Single



Profiler® Smoke Rated Telescoping ICU/CCU

Large Clear Opening System

Available with a smoke-rated label with up to 80 1/4" of clear opening width, this telescoping system allows for easy transfer of patients or medical equipment without the need to breakaway the doors. Offered in widths ranging from 7' to 12'.

Additional Features

- Up to 78% greater opening width than a standard single slide door system
- Track or trackless configurations
- Low profile header for superior aesthetics
- Exceeds the air leakage requirements of NFPA 105



Up to 80 1/4" of clear opening width



Both moving panels slide smoothly open with one-hand operation and close with assurance of positive latching

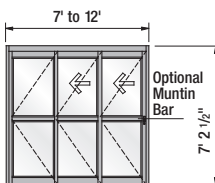

Shown: S0-SX-SX (SX-SX-S0 Reverse)

Type 310T



ICU/CCU Bi-Fold/Bi-Swing™ Multi-Access Combination System

Versatile access of a swing door for normal 2-way traffic and an adjacent folding door dramatically increases the opening up to 6 feet 8 inches for moving patients or medical equipment.

Additional Features

- Available for openings ranging from 6' to 8'
- Breakout openings up to 83"
- Provides multiple options of use
- Reduces the amount of width needed in an opening without sacrificing clear opening space



Bi-Fold Door creates additional clearance for patient and equipment moves



Bi-Swing Door opens conveniently in both directions for normal traffic

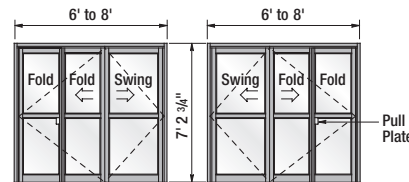

Selection Guide

Model	Type	Unit Width	Max. Clear Opening	Type 110 Breakout Opening	Type 310 Breakout Opening
Profiler®-ICU	Single Slide	7' to 9' (2133–2743)	3' to 4' (914–1219)	3' 3 1/2" to 4' 3 1/2" (1003–1308)	6' 3" to 8' 3" (1905–2515)
	Biparting	8' to 16' (2438–4877)	3' to 7' (914–2133)	3' 7" to 7' 7" (1092–2311)	6' 9 1/2" to 14' 9 1/2" (2070–4508)
	Telescoping	7' to 12' (2133–3658)	3' 9" to 7' 1" (1143–2159)	—	6' 1" to 11' 1" (1854–3378)
Profiler® Self-Closing ICU	Single Slide	7' to 9' (2133–2743)	3' to 4' (914–1219)	3' 3 1/2" to 4' 3 1/2" (1003–1308)	6' 3" to 8' 3" (1905–2515)
Smoke Rated Telescoping ICU/CCU	Single Slide	7' to 12' (2133–3658)	3' 4 1/4" to 6' 8 1/4" (1022–2038)	—	6' 1" to 11' 1" (1854–3378)
ICU/CCU Bi-Fold/Bi-Swing™	Swing/Folding	6' to 8' (1829–2438)	4' 8" to 6' 8" (1422–2032)	4' 11" to 6' 11" (1499–2108)	4' 11" to 6' 11" (1499–2108)

Patient Room Systems



Profiler® Sliding P-X System, SW Washington Medical Center, Vancouver, WA

Patient room systems allow the architect and specifier the option to leave doors completely or partially open without the need to break out the doors. These doors are ideal for optimum space utilization and beauty.

Standard Features

- ▶ Smoke and non-smoke rated systems
- ▶ Multitude of sliding and swinging door configurations
- ▶ Track or trackless (most systems)
- ▶ Wide range of standard or custom widths

“We are glad to have collaborated with Horton Automatics on the Southwest Washington Medical Center project. Not only did Horton implement an aesthetic and superior design that helped us differentiate our offering, but also met stringent time and quality requirements.”

Leigh Sutphin
Principal NBBJ – Seattle



Profiler® Sliding Patient Corridor Door System

Smoke-Rated Corridor Door Design With No Breakout Required

This surface mounted design allows for a clear opening width up to 58 ¾". These systems provide greater flexibility to optimize patient room designs.

Additional Features

- Available with or without horizontal bars
- Available in narrow, medium and wide stile configurations
- Low profile header for superior aesthetics
- Wide range of sizes available



Less than 5 lbs of force required to open and close



Greatest clear opening of any non-breakout smoke-rated door on the market

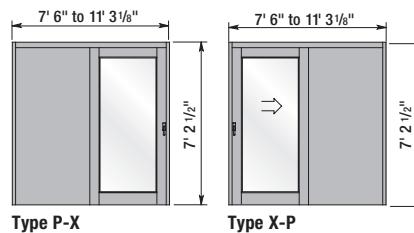

Profiler®-ICU SmokeSwing™

Single, Unequal, & Equal Pair Swing Doors

These smoke-rated systems are ideal for addressing smaller room size opening constraints without sacrificing clear opening space. Available in packages ranging from 3' 3 ½" to 8' 3 ½", these systems allow up to 91" of opening area for easy movement of patients and hospital equipment.

Additional Features

- Available with mini-blind glass for patient privacy, hygiene and beauty*
- Available with fire-rated panel to accommodate square footage requirements when needed
- Trackless flow design for unobstructed flow and expedient traffic management
- No dust or particle build up**

*Mini-blind glass & fire-rated panels also available for single slide door systems

**Opaque glass is also available (non-smoke rated) for privacy at the flick of a switch





Partial open for light control in evening hours

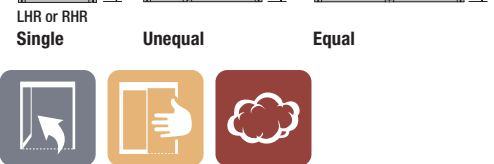
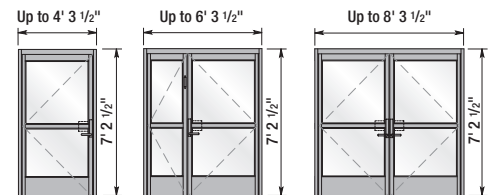

Full close for maximum privacy and light control when needed



Selection Guide

Model	Type	Unit Width	Max. Clear Opening
 Profiler® P-X or X-P	Single	7' 6" to 11' 3 ½" (2286–3432)	3' ¼" to 4' 10 ¼" (921–1492)
	 Profiler®-ICU SmokeSwing™	Single	3' 3 ½" to 4' 3 ½" (1003–1308)
	Unequal	5' 3 ½" to 6' 3 ½" (1613–1918)	4' 7" to 5' 7" (1397–1702)
	Equal	6' 3 ½" to 8' 3 ½" (1918–2527)	5' 7" to 7' 7" (1702–2311)



Negative, Positive, & Combination Pressure Room Systems



Critical for meeting the air infiltration requirements for negative, positive and combination pressure isolation rooms, Horton offers two door systems to address these needs. The 2000-IDS is an automatic door system that opens with your choice of knowing act activation such as touchless sensors or push plates. The alternative mechanical self-closing system requires no power.

Standard Features

- ▶ Self-closing
- ▶ Offers up to 48" of clear opening width

Applications

- ▶ Pediatric Care
- ▶ Intensive Care
- ▶ Intermediate Care
- ▶ Critical Care
- ▶ Newborn Intensive Care
- ▶ Nursery Unit
- ▶ Biohazard Rooms



Airborne Infection Control Isolation Room Doors

Designed to meet the requirements for a negative, positive, and combination pressure room, the Horton 2000-IDS and mechanical self-closing IDS isolation room door systems greatly reduce air leakage and include tested perimeter seals and self-closing devices. These systems are easy to clean and reduce the risk of nosocomial infections. Available in electromechanical or no power self-closing.

Additional Features

- Available with or without power
- Trackless configuration
- Can be used as a patient room system when infection containment is not necessary
- Clear opening widths up to 48"



Automatic isolation room door with "knowing act" touchless system to ensure doors are only opened when activated



Mechanical self-closing system that smoothly closes and positive latches after each opening

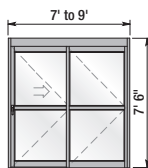

Shown: SX-50 (50-SX Reverse)

Type 310



UltraClean™ Atmospheric Sliding Doors

Designed to meet ISO 14644-1 Class 3 cleanroom standards, the UltraClean™ Atmospheric is ideal for positive pressure rooms where isolating tightly controlled materials is needed. The system comes available in one or two panel configurations with multiple activation options including push plate, pull chain or an overhead motion sensor.

Additional Features

- Available with a 4" by 6" header in single linear drive header
- Trackless configuration
- Available with explosion proof operator
- Clear openings widths up to 48"



Excellent for areas such as labs or pharmacies where ultra cleanliness is required

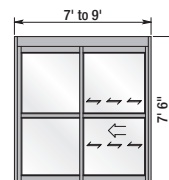

Type 010



Did You Know?

In the United States, there is a -2.5 Pascal negative pressure differential requirement and in Canada, -8.0 Pascal for airborne infection isolation rooms.

Selection Guide						
Model	Type	Unit Width	Max. Clear Opening	Type 110 Breakout Opening	Type 310 Breakout Opening	
	AIRR	2000-IDS	7' to 9' (2134–2743)	3' to 4' (914–1219)	—	6' 3" to 8' 3" (1905–2515)
		Self-Closing IDS	7' to 9' (2134–2743)	3' to 4' (914–1219)	—	6' 3" to 8' 3" (1905–2515)
	UltraClean™	Single Slide	7' to 9' (2134–2743)	3' to 4' (914–1219)	3' 3/2" to 4' 3/2" (1003–1308)	—

Automatic Entrance Systems Sliding



Profilor® 2000B Elite, Yavapai Regional Medical Center, Prescott, AZ



Elegant™

All-Glass, Full Breakout System
For Upscale Health Care Facilities

The all-glass Elegant™ system enhances your building's exterior beauty while offering all the advantages of automatic operation and energy efficiency. Supplied with ½" tempered glass.

Drive Mechanism

Series 2001 belt drive operator

Additional Features

- Frameless, offset glass design
- Heavy duty operator ensures quiet and smooth operation
- Available with up to 76" of clear opening width

Engineered specifically to meet the 24/7 access demands of medical facilities, Horton offers an industry leading range of sliding door entrance systems, all designed for ultimate dependability. At the heart of these hard working systems is the Horton operators with powerful ½ or ¼ HP motors and full microprocessor control with digital displays that make it convenient to keep the systems operating properly and trouble-free.

Series 2000 Linear Drive Operator

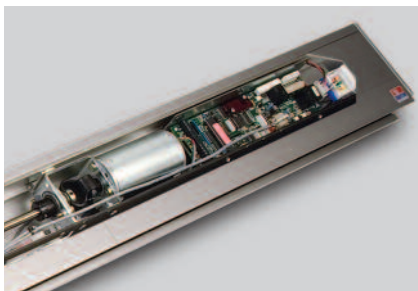

"Horton's leading edge products allow Automatic Door Enterprises a great deal of latitude in providing custom solutions to complex projects such as Paoli and Lankenau Hospitals."

*John Kwartnik
Automatic Door Enterprises – Philadelphia*

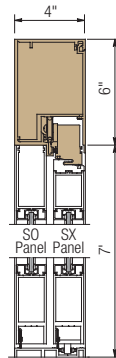

Series 2000 Linear Drive Operator

- Superior aesthetics
- Panels up to 250 lbs
- Supplied with Profilor® and ProfilorStorm®** linear drive and belt drive door systems
- Slim 4" x 6" flush to jamb header
- Durable stainless steel drive shaft with linear clutch action drive block or belt drive

For Type 010, 110 or 310 installations

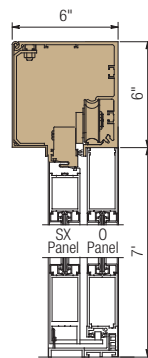

Series 2003 Belt Drive Operator

- Panels up to 250 lbs
- Supplied with ProSlide® and ProSlide® Telescoping door systems
- Durable 6" x 6" header
- ½" steel reinforced neoprene belt

For Type 110 or 310 installations

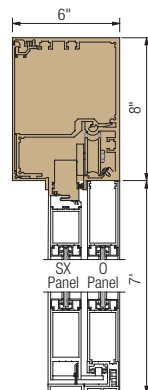

Series 2001 Belt Drive Operator

- Heaviest panels to 300 lbs (bipart) or 500 lbs (single slide)
- Supplied with Elegant®, HD-Slide®, HD-Storm®,** and other custom door systems
- Heavy duty 6" x 8" header
- 1" reinforced neoprene belt

For Type 110 or 310 installations

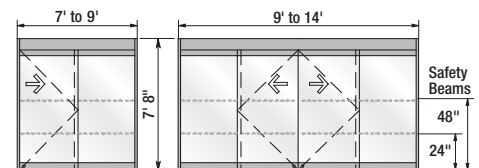

Shown: SX-0 (O-SX Reverse) Shown: O-SX-SX-0
Type 110

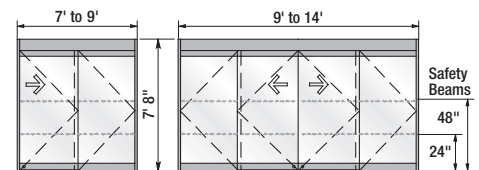

Shown: SX-SO (SO-SX Reverse) Shown: SO-SX-SX-SO
Type 310

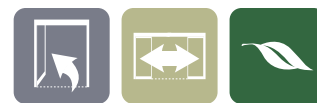

Did You Know?

Horton door systems were used throughout the 2010 Winter Olympics facilities in Vancouver. From the athlete's village to doping control rooms, Horton's slide and swing doors were used in various architectural designs adding elegance and functionality to this world sports venue.



*For additional information on our heavy duty and hurricane product lines, please use your smart phone and click here or go to www.hortondoors.com



Profilor®

Sleek 4" x 6" Header Design
For Greater Architectural Appeal

With the smallest header in the industry, this door system is often selected for its visual appeal. Yet the real advantage is the system's dependability, with fewer parts to wear out and easy adjustments.

Drive Mechanism

Series 2000 linear drive operator
Series 2000B Elite belt drive operator

Additional Features

- Available in hurricane-rated packages
- Custom manufactured to your opening requirements
- Advanced microprocessor controls with built-in diagnostics
- Up to 84" of clear opening

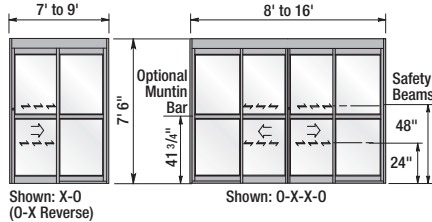

Shown: X-0
(O-X Reverse)

Type 010



ProSlide™

Large Heavy Duty Header Design
For Standard Facilities

Ideal for high traffic applications, this heavy duty system is engineered to provide long life and quiet operation.

Drive Mechanism

Series 2003 belt drive operator

Additional Features

- Heavy duty design
- Custom manufactured to your opening requirements
- Advanced microprocessor controls with built-in diagnostics
- Up to 84" of clear opening

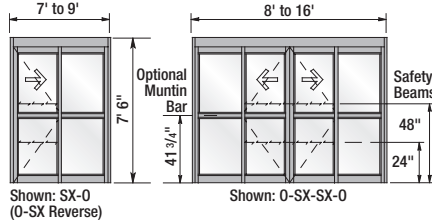

Shown: SX-0
(O-SX Reverse)

Type 110



ProSlide™ Telescoping

Large Net Slide Opening Design
For Smaller Spaces

This system is ideal for automatic sliding door access in narrow passageways, effectively increasing the opening width more than 35 percent. Available in single or biparting configurations.

Drive Mechanism

Series 2003 belt drive operator

Additional Features

- Heavy duty design
- Ideal for emergency room vestibules
- Available with muntin bars
- Clear opening widths up to 105 1/2" available

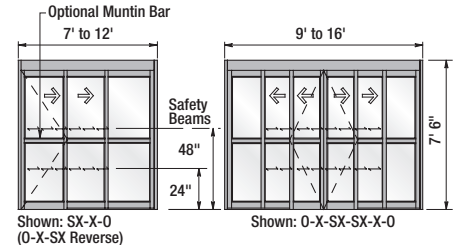

Shown: SX-X-0
(O-X-SX Reverse)

Type 110T

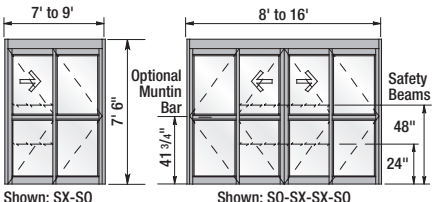

Shown: SX-S0
(S0-SX Reverse)

Type 310

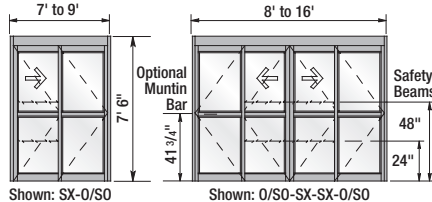

Shown: SX-O/S0
(O/SX-S0 Reverse)

Type 410

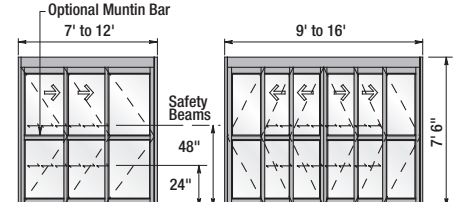

Shown: SX-SX-S0
(S0-SX-SX Reverse)

Type 310T



Selection Guide		Unit Width	Max. Clear Opening	Type 110 Breakout Opening	Type 310 Breakout Opening
Elegant™	Single	7' to 9' (2134-2743)	3' to 4' (914-1219)	3' 1/4" to 4' 1/4" (959-1264)	6' 3" to 8' 3" (1905-2515)
	Bipart	9' to 14' (2743-4267)	3' 6" to 6' 4" (1067-1930)	3' 10" to 6' 4" (1168-1930)	7' 9 1/2" to 12' 9 1/2" (2375-3899)
Profilor® & ProSlide™	Single	7' to 9' (2134-2743)	3' to 4' (914-1219)	3' 3/2" to 4' 3/2" (1003-1308)	6' 3" to 8' 3" (1905-2515)
	Bipart	8' to 16' (2438-4877)	3' to 7' (914-2134)	3' 7" to 7' 7" (1092-2311)	6' 9 1/2" to 14' 9 1/2" (2070-4509)
ProSlide™ Telescoping	Half	7' to 12' (2134-2743)	3' 7 1/2" to 6' 11 1/2" (1105-2121)	2' 1 1/4" to 3' 9 1/4" (641-1149)	6' 1" to 11' 1" (1854-3378)
	Biparting	9' to 16' (2743-4877)	4' 1 1/2" to 8' 9 1/2" (1257-2680)	2' 7 1/2" to 4' 11 1/2" (800-1511)	7' 5" to 14' 5" (2261-4509)

Automatic Entrance Systems Swinging & Folding



HD-Swing® LE, Yavapai Regional Medical Center, Prescott, AZ



HD-Swing™ Heavy Duty Operator

Available in our widest range of configurations, the Series 4000 operator is ideal for a number of health care uses.

Additional Features

- Choice of header models for surface applied or overhead concealed installations
- Preset for left or right hand operation and easily field modified if desired
- Simple adjustments for low energy handicap or high traffic applications
- Single acting spring always returns door to a closed position, with adjustable speed and force
- Compatible with all electrical or mechanical hardware

Overhead Concealed Operator

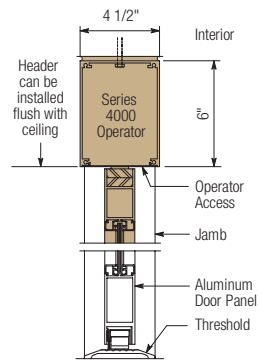

Series 4500 Bottom Access Direct Drive

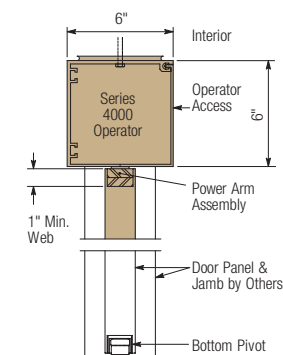

Series 4800 Side Access Direct Drive



Whether for new construction or an existing health care facility, Horton Automatics swing and folding door systems provide a full range of solutions for ADA compliant handicap or high traffic automatic access. These systems come standard with AAADM certified installation.

Swing Operator Features Series 4000 and Series 7000 Operators

- ▶ Adjustable opening and closing speeds
- ▶ Adjustable time delay closing (2–30 seconds)
- ▶ Push-N-Go® activation for door opening assistance
- ▶ SoftTouch® reverses the door to the open position if it is stopped during closing
- ▶ Obstruction sensing reduces opening speed when obstructed

Options

- ▶ Single, pair or double egress door operation
- ▶ Choice of in-swing, out-swing, left or right hand configurations
- ▶ Available as surface applied operator or overhead concealed package complete with door and frame
- ▶ Available for folding door configurations

Applications One-Way or Two-Way Traffic

- ▶ Entrances
- ▶ Corridors
- ▶ Fire Doors
- ▶ Patient Rooms

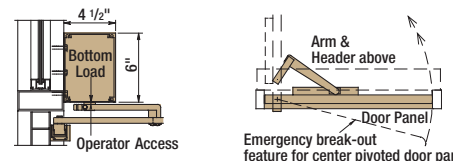
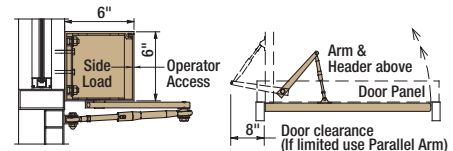
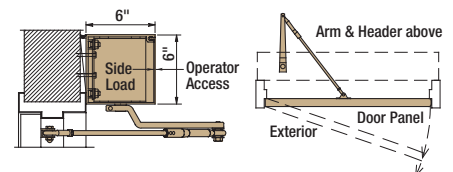

Surface Applied Operator Configurations

Series 4000 HD-Swing™ heavy duty operator with custom finish





EasyAccess®

Low Energy ADA Compliant Handicap Operator

The Series 7000 operator is ideal for new or converted barrier-free openings per ANSI A117.1 & A156.19 (ADA).

Additional Features

- Automatic opening with knowing act activation
- Easily adjustable opening and closing speeds
- Surface applied mounting
- Push-N-Go® feature, SoftTouch® reversing and obstruction sensing
- Available in 4" x 6" or 6" x 6" side access headers
- Compatible with all electrical or mechanical hardware

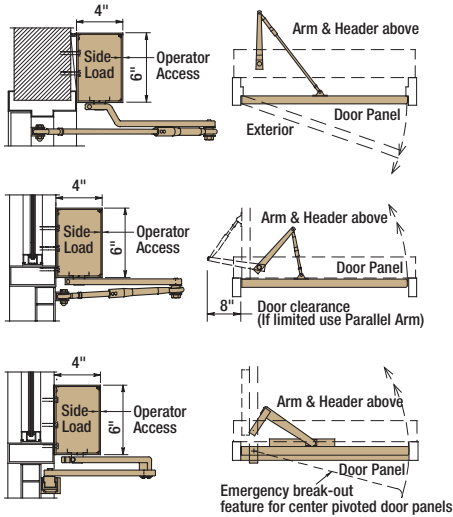

Surface Applied Operator Configurations



Did You Know?

Sometimes operators for interior applications are placed in the wrong section of the Master Specification. Placing operators in sections 08 42 29.33 or 08 71 13 rather than 08 06 71 or 08 71 00 ensures that an AAADM certified installation occurs.



Other Swing Door Packages

Custom Application Swing Closer

Package includes overhead concealed hydraulic closer with frame and center-pivoted doors. Doors are double-acting and can be right or left hand. This package is often used in multiple door installations where a manual swing door is located next to automatic sliding or revolving doors.

Specialty Operators

Super Duty Swing Door Operator

The opening and closing force provided by the Series 4700 surface applied operator is adjustable and delivers substantial torque at the output shaft. With its powerful motor, this operator can operate extremely heavy doors (up to 1500 pounds) such as hospital X-ray lead-lined or storage vault systems.

HD-Swing® LE

Universal Low Energy ADA Compliant & Heavy Duty Operator

The Series 4000LE is ideal for use with large, heavy doors required to meet ANSI A117.1 & A156.19 ADA requirements as well as high traffic hospital corridor environments.

Additional Features

- Heavy duty drive for taller and heavier doors
- Choice of in-swing, out-swing, left or right handed
- Applicable for surface applied or overhead concealed configurations
- Available in 4 1/2" x 6" bottom access or 6" x 6" side access header
- Compatible with all electrical or mechanical hardware



FoldingAccess™

Narrow Corridor Folding Door

Ideal for vestibules and hospital corridors that require wide openings in a narrow space. Each FoldingAccess™ package includes Vista® sensing technology for full automatic operation. The system may also be specified for manual operation.

The folding design incorporates the built-in safety of emergency breakout and a low closing force of less than 15 lbs. Available with magnetic lock and panic hardware.

Additional Features

- Emergency breakout
- Finger guards at all hinge points
- Accommodates 1 or 2 way traffic
- Also available in manual opening styles for ICU applications
- Compatible with all electrical or mechanical hardware

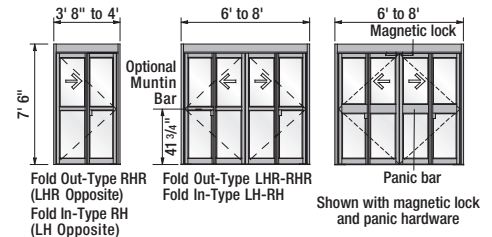

Selection Guide			
Type	Unit Width	Maximum Clear Opening	Maximum Breakout Opening
Single (2 panels)	3' 8" to 4' (1118-1219)	2' 8" to 3' (813-914)	2' 11" to 3' 3" (889-991)
Pair (4 panels)	6' to 8' (1829-2438)	4' 4" to 6' 4" (1321-1930)	4' 11" to 6' 11" (1499-2108)

"I just want to say thank you very much for your automatic doors! I am in a wheelchair and your doors simplify my life incredibly."

Briony Chisholm
Cape Town, South Africa



Automatic Entrance Systems Revolving



MiniGrand® Revolving Door, Fhn Family Healthcare Center-Burchard Hills, Freeport, IL

Estimate the Energy Savings Online

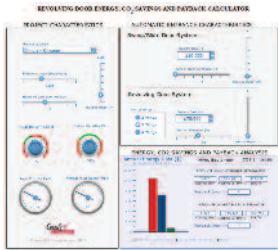

Determine the energy savings, CO₂ emissions, and payback of using Horton revolving doors!

Compare the energy savings of using a revolving versus a swing and/or slide door system. Also see how much a revolving door reduces carbon dioxide emissions and provides rapid return on investment. To use the calculator, visit hortondoors.com/EnergySavingsCalculator.aspx.

Horton Grand® and MiniGrand® revolving door systems are ideally suited to the traffic requirements of health care facilities. They offer impressive architectural appeal, generous openings and the extra advantage of a constant seal for energy efficiency and LEED credits.

Standard Features

- ▶ Easily customized with special finishes, metal cladding, roof panel designs, lighting, Segmented® or round wall design as well as extended canopies
- ▶ Smooth, quiet operation with emergency egress panels
- ▶ Constant seal reduces drafts and helps control energy costs

Applications

- ▶ Main Entrances
- ▶ Emergency



Increase energy savings by specifying a Horton Revolving Door.

Did You Know?

A 2006 MIT study concluded that revolving doors act as airlocks minimizing a building's heating and air conditioning losses. According to the study, revolving doors generate energy savings up to 74% when compared to other entrance alternatives.



Grand® Core Vestibule Design

This system provides spacious compartments for an elegant, energy efficient entrance. With diameters up to 16 feet, this system is ideal for managing high traffic volumes including wheelchairs, walkers and stretchers.

Additional Features

- Segmented® or round design
- Smooth, continuous rotation
- Auto rotation with VistaScan™**
- Customizable voice enunciator
- StormLock™*** feature for high wind and stack pressure conditions

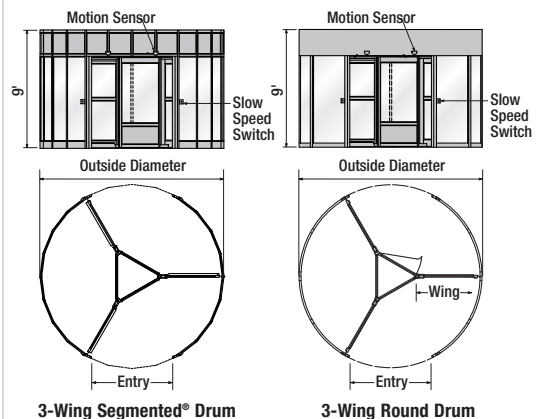

Selection Guide

Outside Diameter	Segmented® Drum Entry - 3 Wing	Round Drum Entry - 3 Wing
12' (3658)	5' 3 3/4" (1619)	5' 1 1/2" (1565)
14' (4267)	6' 3 3/4" (1924)	6' 1 1/2" (1870)
16' (4877)	7' 3 3/4" (2229)	7' 1 1/2" (2175)



To view our new revolving door video, use your smartphone to access the QR code.

*VistaScan™ slows or stops doors in motion when objects are within 8 to 12 inches of the door wings

**StormLock™ prevents doors from breaking out unless initiated by human intervention



MiniGrand®

Center Pivot Vestibule Design

The MiniGrand® offers the drum construction of a Grand® revolver along with the compact design made possible by center pivot door wings. This versatile door system is available in 11 and 12 foot diameters.

Additional Features

- Segmented® or round drum design
- Smooth continuous rotation
- Auto rotation with VistaScan™*
- Magnetic locks available for high wind and stack pressure conditions

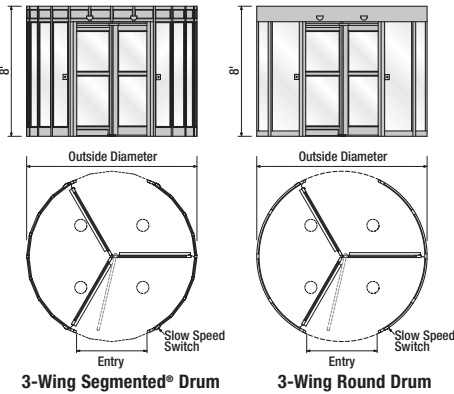

Selection Guide		
Outside Diameter	Segmented® Drum Entry - 3 Wing	Round Drum Entry - 3 Wing
11' (3353)	4' 9 3/4" (1467)	4' 7 3/4" (1413)
12' (3658)	5' 3 3/4" (1619)	5' 1 1/2" (1565)



Manual revolving door systems are also available for alternate entrances that feature glass ceilings and elegant door panels to add drama along with function



ControlFlow™

Automatic Security Door Systems

Available in a choice of 1 or 2 way card access, these systems have a number of options for security including Level III bullet resistant glass, Visdom HS® advanced 3D anti-piggybacking/anti-tailgating prevention sensors and overhead sensors in place of mats (two way only).

Additional Features

- Segmented® or round drum design
- Wireless programming options
- Customizable voice enunciator
- Magnetic breakaway for emergency egress

1-Way

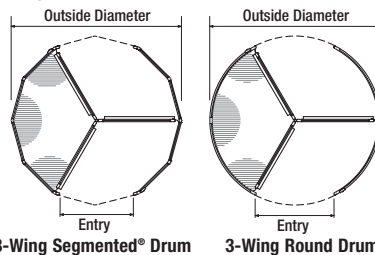

3-Wing Segmented® Drum 3-Wing Round Drum

2-Way Card Access

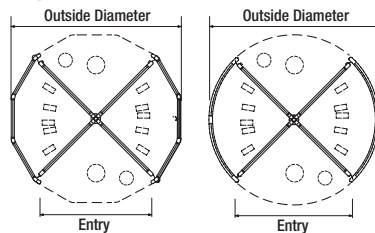

4-Wing Segmented® Drum 4-Wing Round Drum



Selection Guide			
Segmented® Drum		Round Drum	
Inside Diameter	Entry	Inside Diameter	Entry

3 Wing (1-Way)			
8' (2438)	3' 4 3/8" (1026)	8' (2438)	3' 6 3/8" (1089)
9' (2743)	3' 10 3/8" (1178)	9' (2743)	4' 1/8" (1241)
10' (3048)	4' 4 3/8" (1330)	10' (3048)	4' 6 3/8" (1394)

4 Wing (2-Way)			
6' (1829)	3' 10" (1168)	6' (1829)	3' 10 3/8" (1191)
6' 6" (1981)	4' 2 3/4" (1280)	6' 6" (1981)	4' 3 3/8" (1299)
7' (2134)	4' 6 3/4" (1391)	7' (2134)	4' 7 3/8" (1407)



Security Windows

Automatic • Security • Manual

Specified for hospital drive-through pharmacies, labs, supply rooms and other secure interior areas, these windows can be equipped with transaction drawers, bullet resistant glass, a choice of counter tops and other custom features.

Standard Features

- Fully assembled for easy installation
- Auto-close and reverse-on-contact functions
- Maximum security locks
- Manual or automatic packages

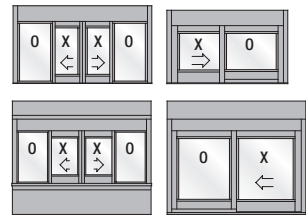

X - Slide Panel O - Fixed Panel



Selection Guide		
Window/Unit Type	Size	Maximum Slide Opening

2 Panel O-X or X-O	45 1/2" to 50" (1156 to 1270)	16" to 20 1/2" (406 to 521)
------------------------------	----------------------------------	--------------------------------

*With 1" insulated glass or 1/4" prep without glass.
Also available with recessed pull*

2 Panel - Security O-X/O-X or X-O/X-O	50 1/4" (1276)	20 1/2" (521)
-------------------------------------------------	----------------	---------------

With synchronized interlocking slide panels

4 Panel O-X-X-O	53 1/2" (1359)	21" (533)
---------------------------	----------------	-----------

*With thin stile panels, 1/4" tempered glass
Also available with 1/4" glass canopy, stainless steel counter and metal apron*





Setting the Standards for Professional Installation and Service

Horton Automatics brings you the professional support of factory-authorized independent distributors. Whether your application involves a single automatic operator or a complete facility access and security plan, you can expect all phases of the project to be handled professionally.

All Horton systems are built to exceed applicable quality and safety standards including:

- ANSI standards for pedestrian doors
- 1990 ADA requirements for barrier-free entrances
- Tested to UL 1784 to meet National Fire Protection Association (NFPA) regulations
- National building codes related to emergency exits
- American Testing Laboratory ratings for wind load and forced entry
- CSA, IBC, BOCA, Miami-Dade and other regional requirements
- Listed by Intertek (ETL) for compliance to UL 325 Electrical Door, Drapery, Gate, Louver, and Window Operators and Systems

Call your Horton Automatics distributor today for design, specification and application assistance. Visit www.hortondoors.com to find the nearest distributor in your area.

AAADM *American Association of Automatic Door Manufacturers*

Specify Horton and demand AAADM certified installation.

Did you know?

Access issues and properly maintained door systems are now an important component of JCAHO* inspections? Ask your Horton Automatics distributor to provide regular preventive maintenance that will help assure swift approval on this portion of your accreditation.

*Joint Commission on Accreditation of Healthcare Organizations

Quick Response (QR) Codes for your Smart Phone



Website



Design Catalog



Healthcare Product Video



Revolving Door Video



Horton Automatics
World Headquarters
 4242 Baldwin Boulevard
 Corpus Christi, Texas 78405-3399 USA
 Phone: 800-531-3111, 361-888-5591
 Fax: 361-888-6510
www.hortondoors.com

Horton Automatics, Ltd.
United Kingdom
 Unit A, Hortonwood 31
 Telford, Shropshire, England TF1-7YZ
 Phone: 01952 670169
 Fax: 01952 670181



Horton Automatics is a division of Overhead Door Corporation, an innovative industry leader with many firsts in upward-acting doors and electric openers for residential as well as commercial applications.

